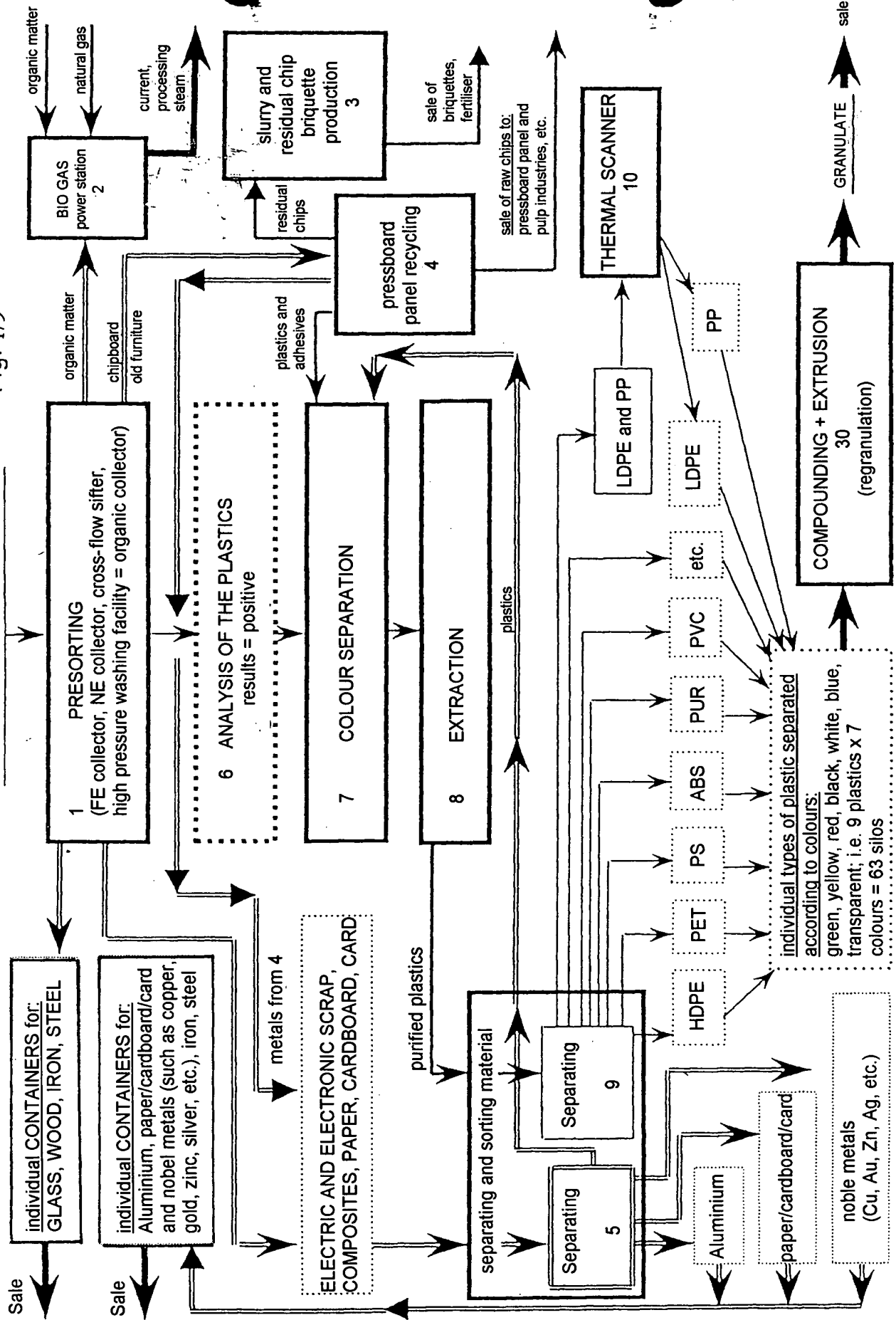
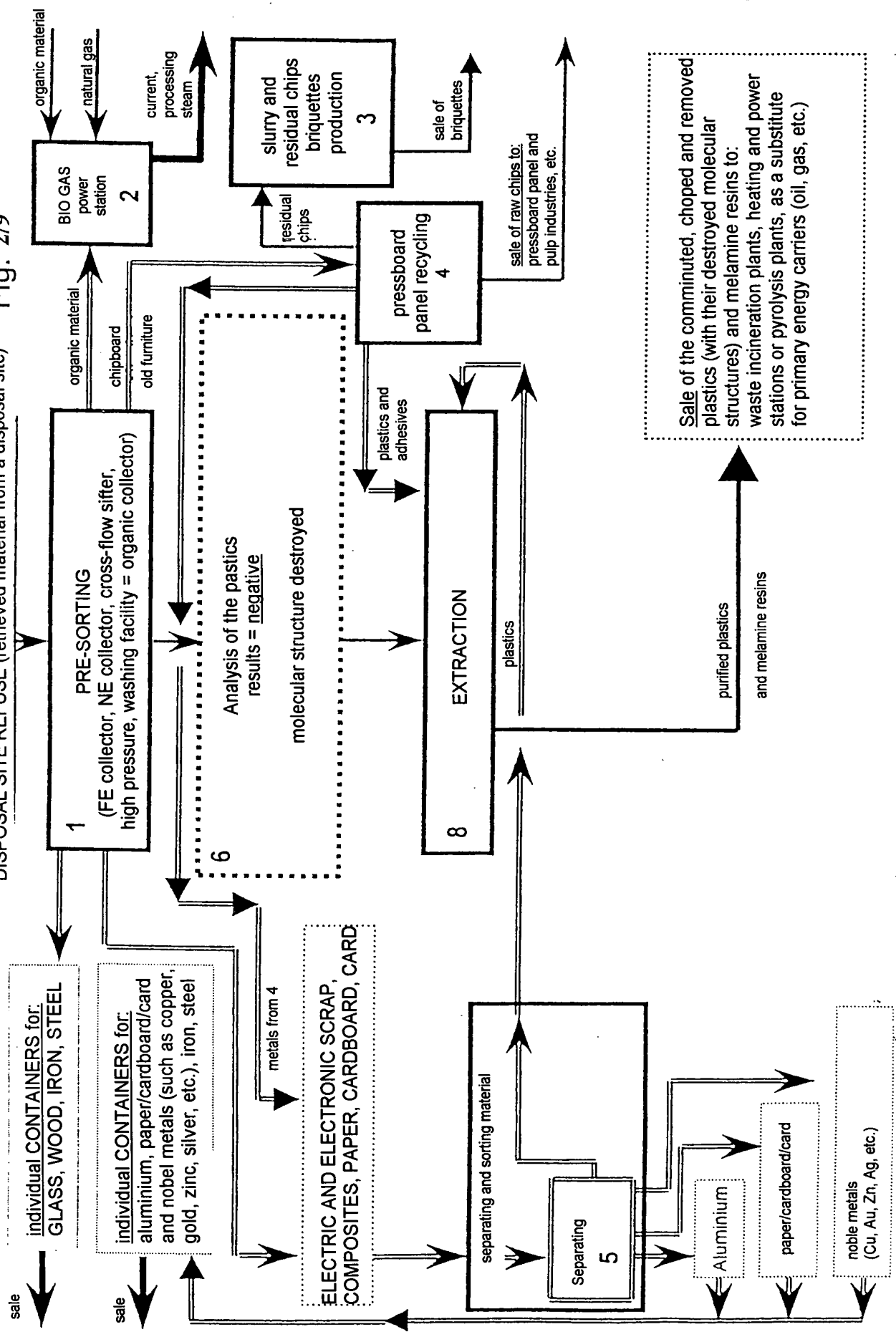

Fig. 1/9



DISPOSAL SITE REFUSE (retrieved material from a disposal site) Fig. 2/9



THERMAL SCANNER Fig. 3/9

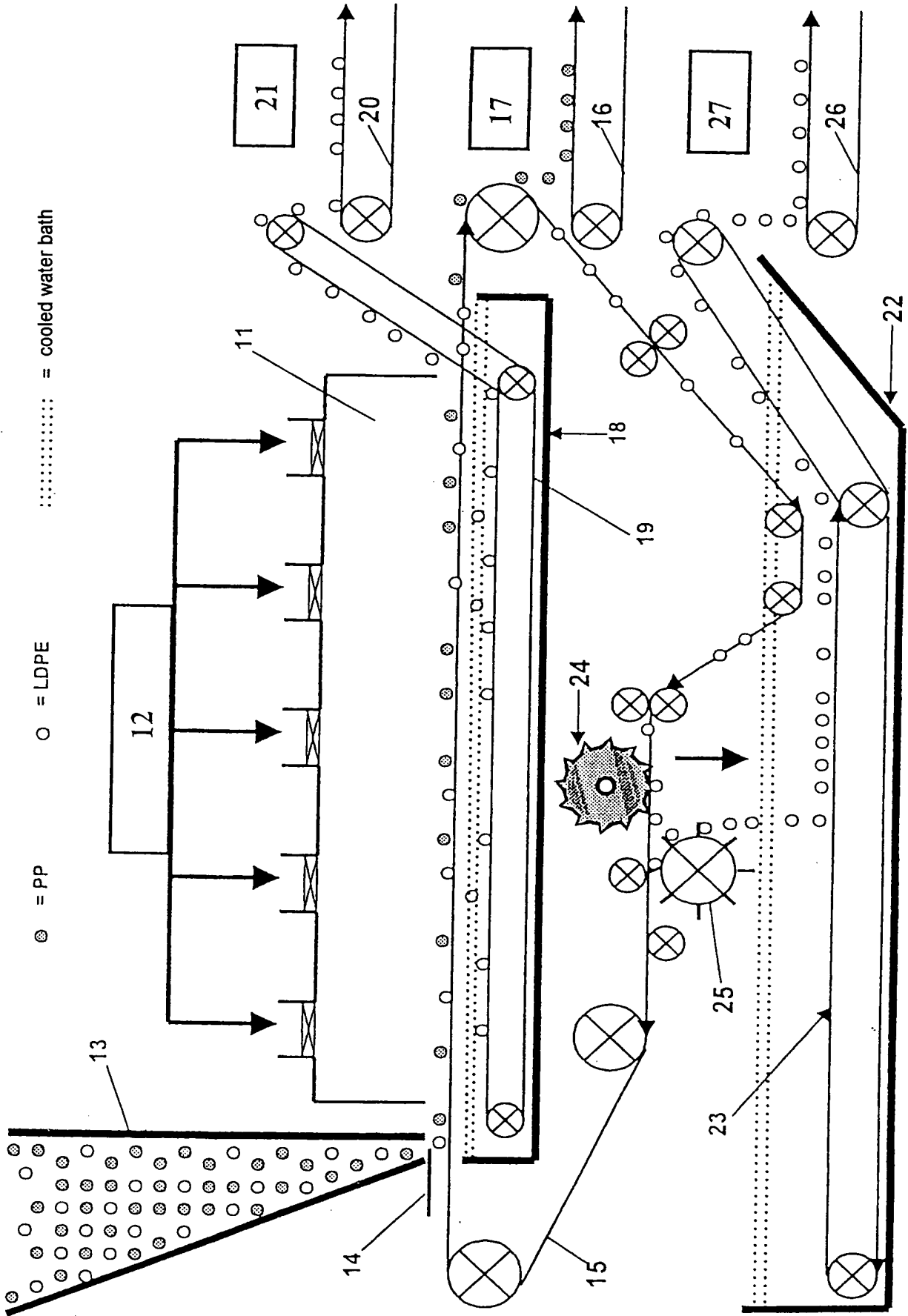

VALUABLE SUBSTANCES / REFUSE / BULKY WASTE

Refuse from primary circulation (i.e. from the final consumer)

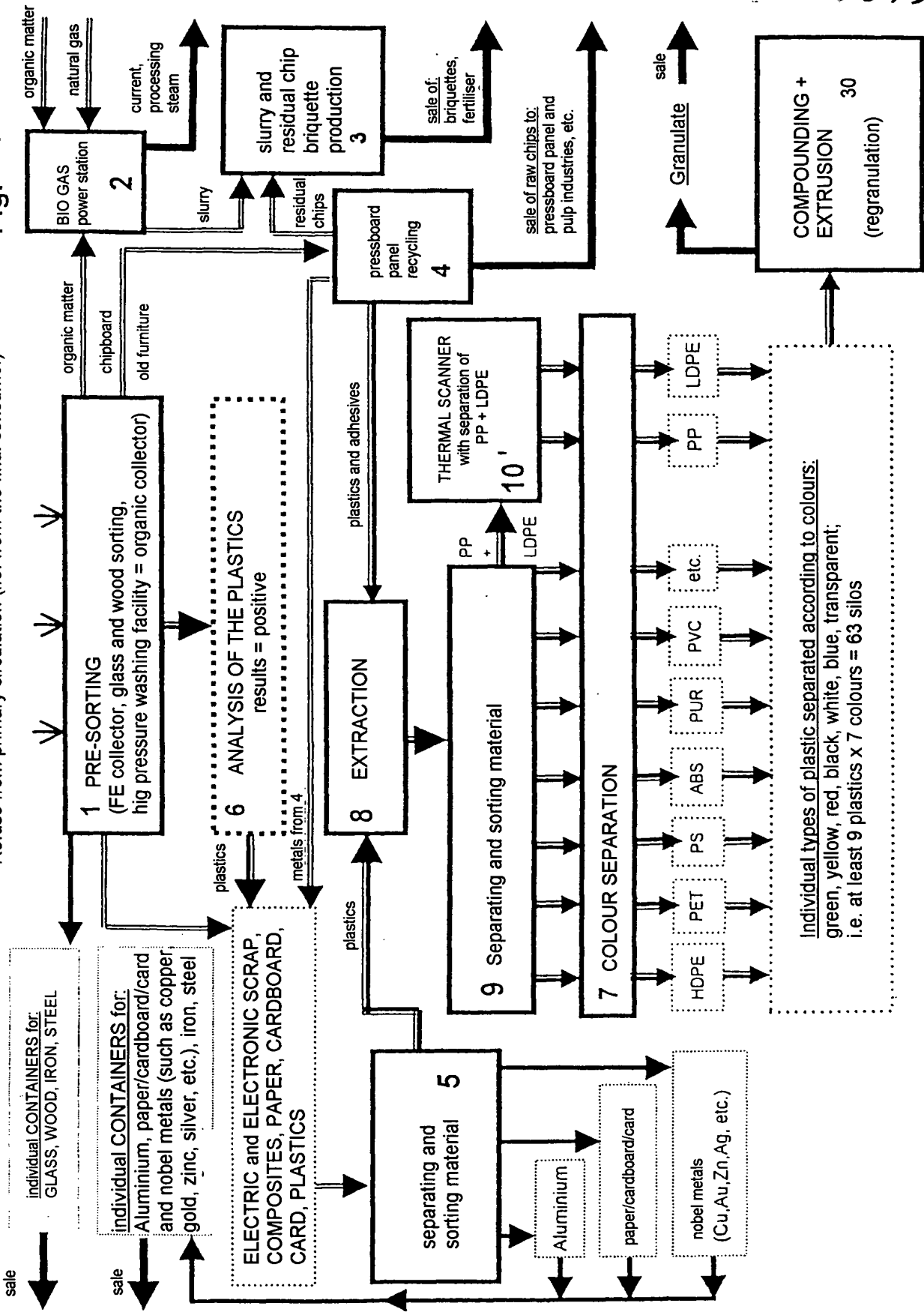
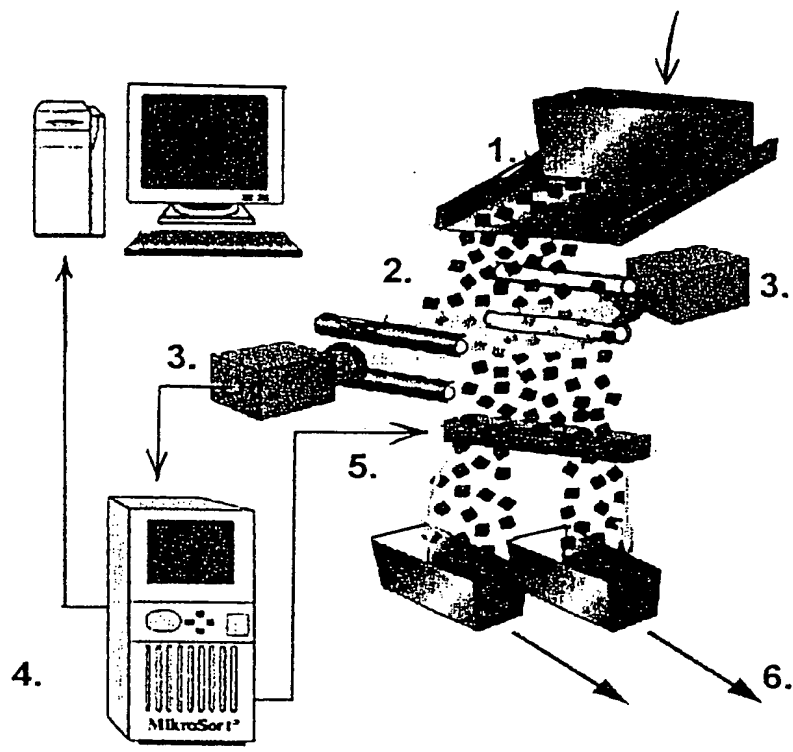

Fig. 4/9

Fig. 5/9



205740" E F E 6 0 0 1

DISPOSAL SITE REFUSE (retrieved material from a disposal site) Fig. 6/9

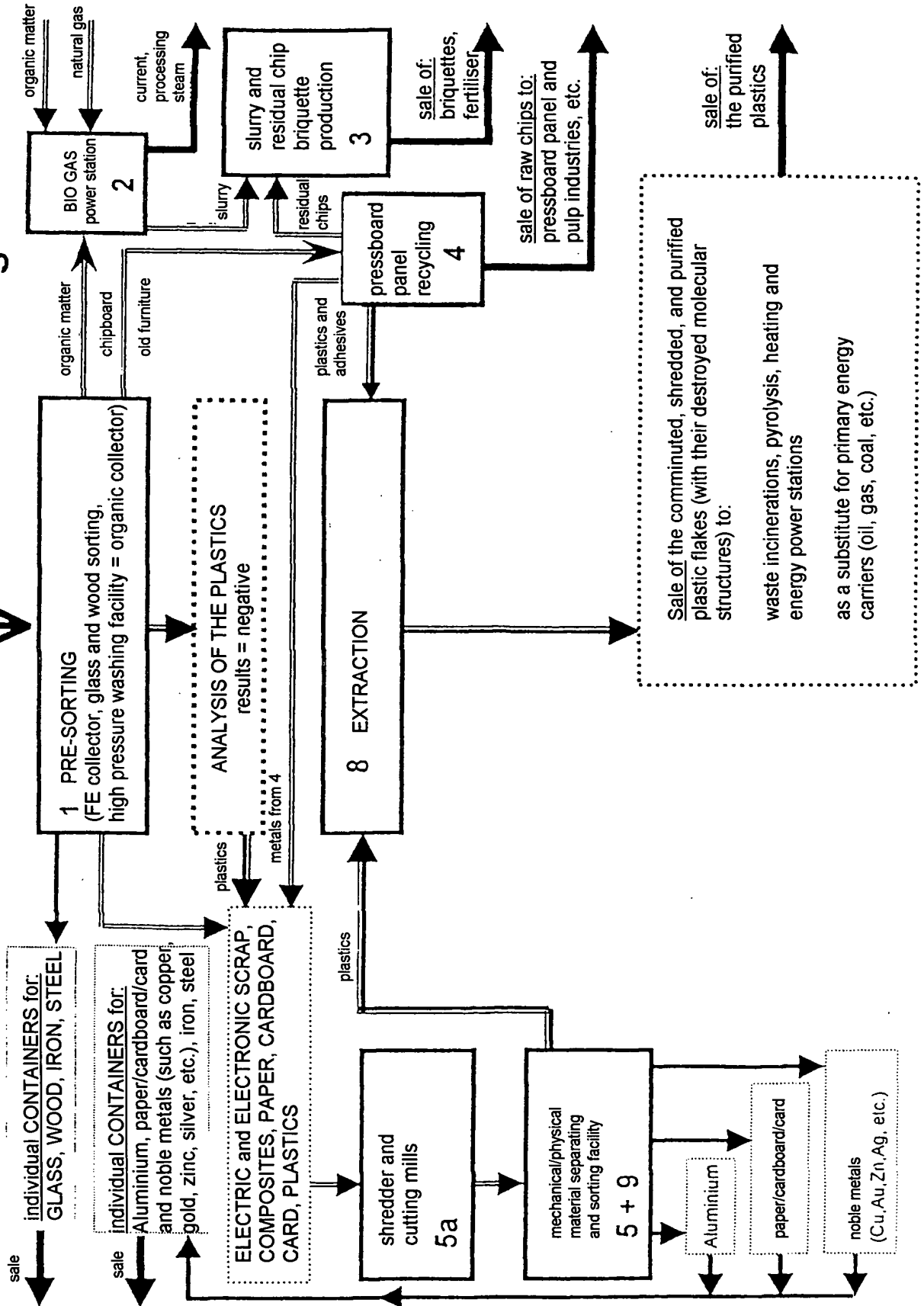

THERMAL SCANNER comprising opto-electronic colour and type-separation

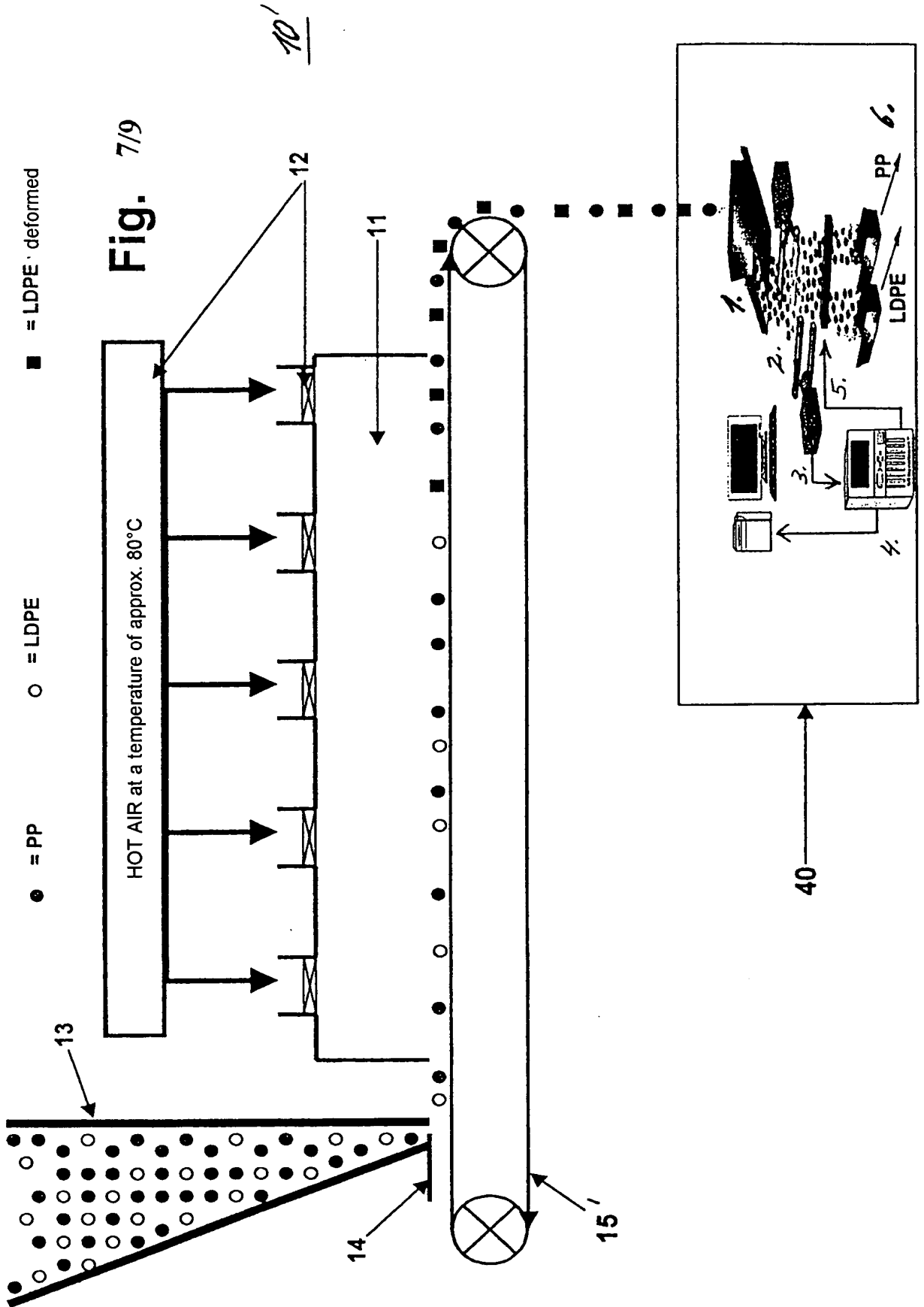

For direct sale:

Glass, wood, paper, cardboard, card aluminium, iron/sheet metal/steel, noble metals (copper, tin, zinc, etc.)

"Grüne Punkt" SYSTEM

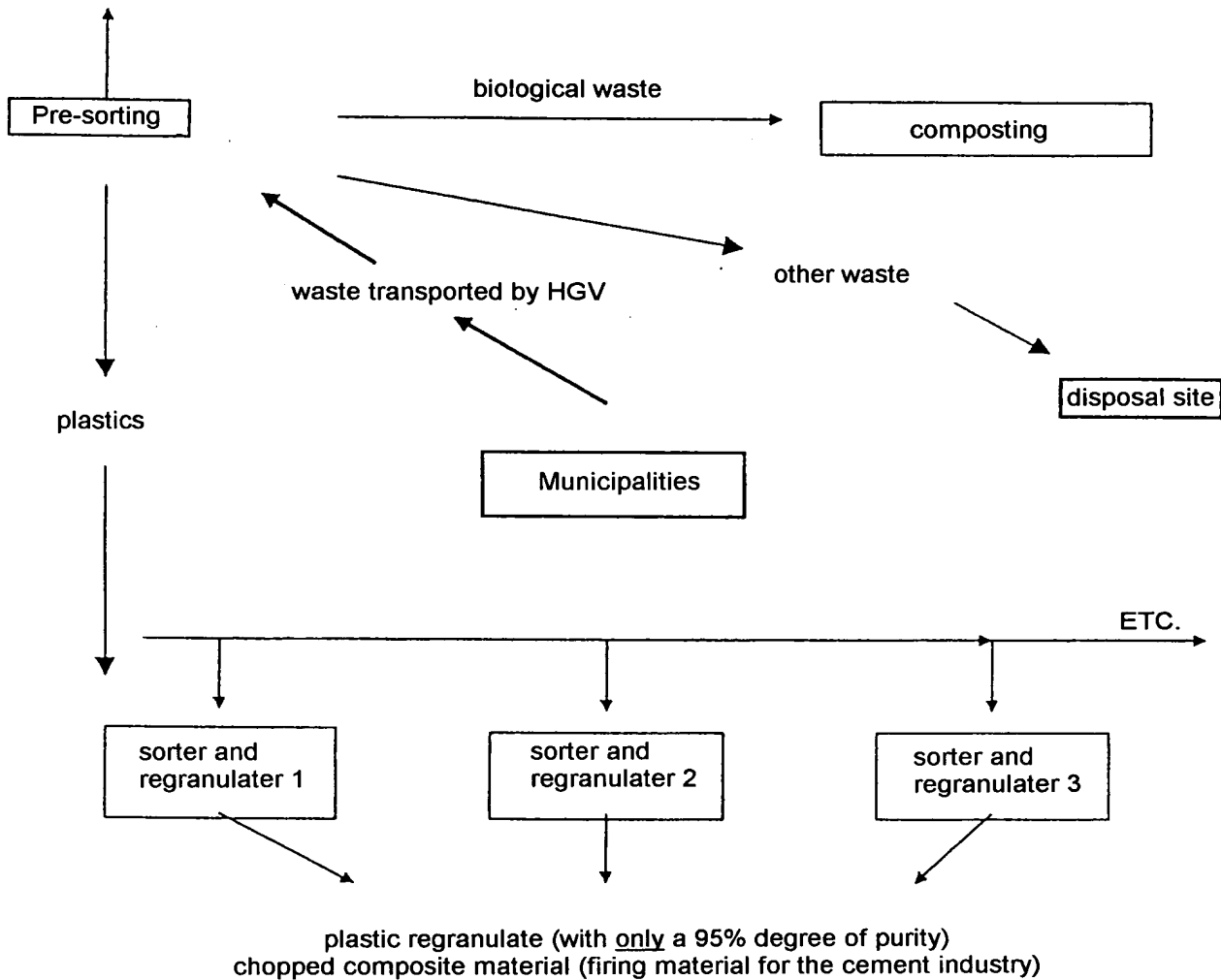

Advantages:

- valuable substance are reclaimed.
- no waste incineration / no valuable substances destroyed
- little exhaust gas, no filter dust.
- no primary energy destroyed by firing.

Disadvantages:

- large hauling distances
- cannot reclaim the aluminium in composite material. cannot recycle composite material.
- the plastic regranulate has a degree of purity of only 95%.
- the compost is highly subsidised, as there is no market for it.

WASTE INCINERATION in Europe

Fig. 9/9

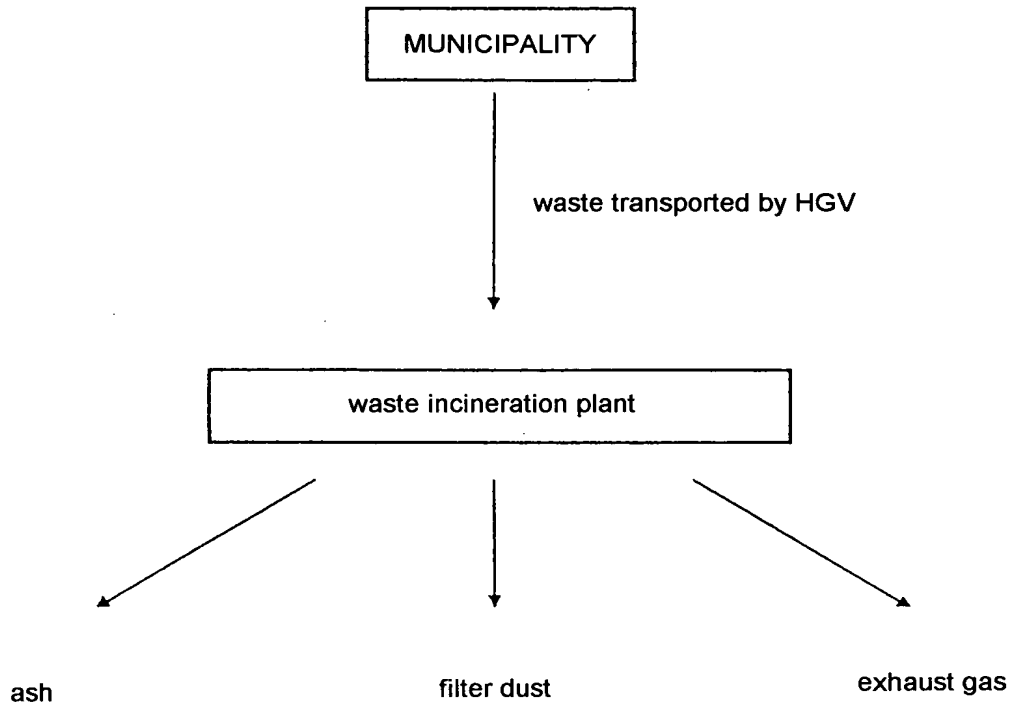

Advantages:

- there is no costly pre-sorting.
- the waste incineration plant can process any waste that turns up.

Disadvantages:

- ash is created which has to be specially disposed of, because it contains loaded residues such as aluminium oxide.
- filter dust is created which turns up in the flue gas washing facility and has to be specially disposed of because it contains poisons, e.g. furanes, dioxines, or their combustion residues.
- transporting the waste to the incineration plant requires wide roads leading up to it, because of the enormous capacity of at least 200,000 tonnes per year. this creates considerable transport costs.
- considerable quantities of primary energy, such as gas or heating oil, have to be fired in order to incinerate e.g. biological waste (cut grass, etc.)
- the large amount of HGV traffic is an annoyance to nearby residents.
- valuable substances are destroyed.
- 3 tonnes of burning material creates 1 tonne of slag to be disposed of, i.e. the recycling rate is only 66%.